



**HERMAN MILLER SANTÉ**  
CATALOGUE CHARIOTS MOBILES



**MOBILIERS &  
EQUIPEMENTS  
HOSPITALIERS**

[www.hmsante.com](http://www.hmsante.com)

# SOMMAIRE

## Chariots

## Secteurs

## Références

## Pages



### SOINS

HMS-MBX2300

6

HMS-CLP1110

7

HMS-MHT3210

7

HMS-CLS2210

7



### DHIN

HMS-MHX22002KS

8

HMS-CLS10101KS

9

HMS-MH22002KS

9

HMS-MHX2103KS

9

HMS-MH21003KS

9



### DJIN

HMS-MHXT0300-3P

10

HMS-MHT0210-3P

11

HMS-MHXT4300

11

HMS-MHXT1300-2P

11



### DIALYSE

HMS-MHX0500

12

HMS-CLS0030

13

HMS-MH0600

13

HMS-MHDXST01000

13



### NURSING

HMS-3NVX-110

14

HMS-MBDSS1100-1ED

15

HMS-MHDXSS0201

15

HMS-3NVX-800

15

HMS-3NVX-1300

15

# SOMMAIRE

Chariots

Secteurs

Références

Pages



## ANESTHESIE

HMS-MHX2400	16
HMS-MHX4300	17
HMS-MHDST6420	17
HMS-MBDXST2600	17



## URGENCES

HMS-MBX4200	18
HMS-MH3210	19
HMS-MB3110	19
HMS-MHX0500	19



## INFORMATIQUE

HMS-MBXT5100-1P	20
HMS-CLS0110-1P	21



## PERSONNALISATION

FINITIONS	22
VUE ÉCLATÉE	23



CRÉEZ VOTRE CHARIOT EN 5 ÉTAPES  
À LA FIN DU CATALOGUE

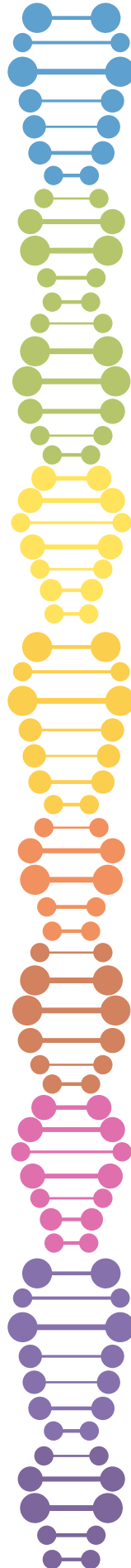

**1** **CENTRÉ SUR L'HUMAIN**  
Conçu par vous et pour vous

**ANALYSE** **2**  
Nous vous proposons des solutions innovantes pour améliorer votre quotidien

**3** **ÉCOUTE**  
Nous gérons votre besoin dans sa globalité

**ORIGINAL** **4**  
Parce que nous ne copions pas !

**5** **GARANTIE**  
L'assurance d'un travail et de produits d'une grande qualité

**ENVIRONNEMENT** **6**  
Nos pièces détachées et nos accessoires permettent de réactualiser votre mobilier, même le plus ancien

**7** **SIMPLICITÉ**  
Un système d'accessoires compatibles et démontables sans outils

**MODULARITÉ** **8**  
Nos produits sont interchangeables et modulables entre eux

**9** **DURABILITÉ**  
Nos produits sont reconnus pour avoir une longévité inégalée

**VOUS SATISFAIRE !** **10**  
Vous serez toujours notre meilleure publicité

# GAMME DE CHARIOTS MOBILES

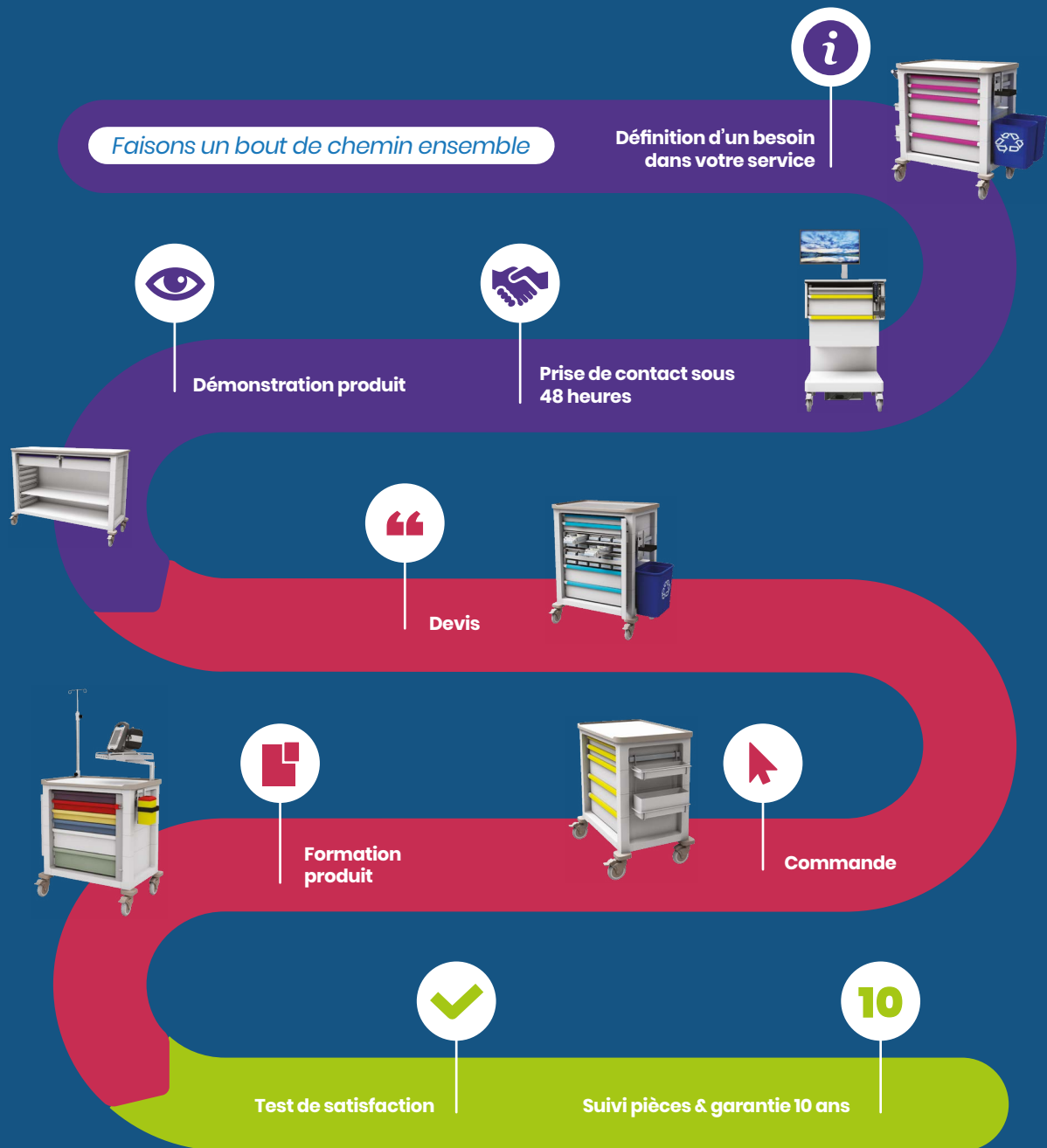

Définition d'un besoin

Réalisation de votre projet

Conclusion : Réponse à votre besoin

## Ce qui nous rend différent



### Conception & Design

Une gamme pensée pour être conçue par vous même.



### Flexibilité

Adaptabilité et rapidité face aux changements, les maîtres mots de la modularité.



### Ergonomie

De votre santé dépend notre santé.



### Facilité de nettoyage

Vous faciliter la vie pour la prévention et le contrôle des maladies nosocomiales.



### Environnement

Eco-conception  
Conçue à partir de 30% de matière recyclée et recyclable à 70%.



### Garantie

Soyez serein, nous sommes là pour 10 ans.

# CHARIOTS DE SOINS

Résistance aux chocs, rayures, ne rouille pas et garde un aspect impeccable dans le temps

Structure en résine injectée, teintée dans la masse. Anti-UV et Anti-feu

Joint souple uréthane, pare-choc

Large plan de préparation aux bords doux et arrondis

Poignée de traction

Entièrement personnalisable sans outils

Bumpers anti-choc

Roues diamètres 125

Référence  
(Hors accessoires)

**HMS-MBX2300**



## Accessoires conseillés



Tablette rabattable  
CT750L ou R



Côté sale simple tri  
CT726 + CT734.02 + ACHCOR GXL



Côté sale double tri  
CT726 + CT734.02 + 2 ACHCOR P



Boîte multifonctions  
HMS-BTE MULTI



Support boîte à gants et porte documents  
ACHBG3R + CT730-BAU



Support flaconnage A3/B3  
ACHSUB A3/B3

# CHARIOTS DE SOINS

Hygiène : Poignée séparée du plan



Référence

HMS-CLS2210

Tablette coulissante gauche ou droite

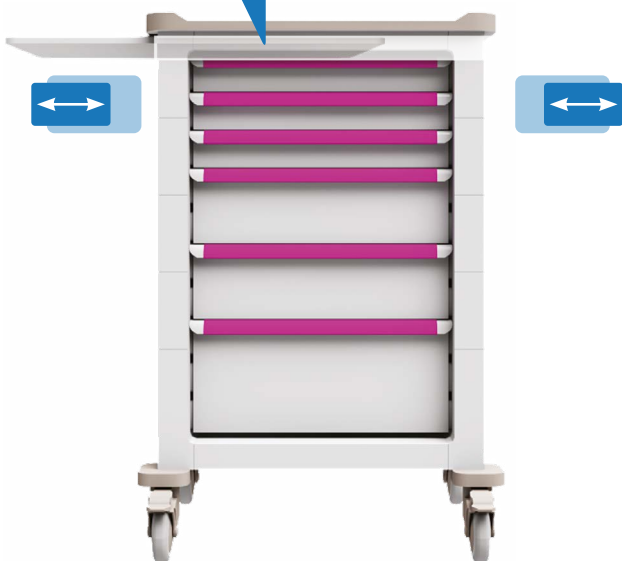

Référence

HMS-MHT3210

## PRÉVENTION DES INFECTIONS

Le chariot L : Totalement démontable et modulable en moins de 1 MINUTE. Existe aussi en magnétique pour la médecine nucléaire et la radiologie, jusqu'à 3,5 tesla



1 min



Sans outils !



Référence

HMS-CLP1110

# CHARIOTS DE DISPENSATION DHIN

Bac coulissant nominatif, limite le risque d'erreur

Barre de sécurité claquable



Référence  
(Hors accessoires)  
**HMS-MHX22002KS**

20 PATIENTS

- 
- 
- 
- 
- 
- 10**

## Accessoires conseillés



Tablette Rabattable  
CT750L ou R

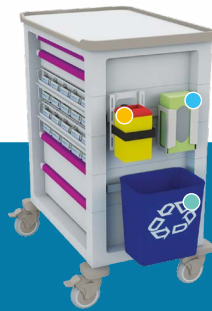

Côté sale simple tri  
CT726 + CT734.02 + ACHCOR G



Côté sale double tri  
CT726 + CT734.02 + 2 ACHCOR P



Support flaconnage B3/B3  
ACHSUB B3/B3



Support boîte à gants  
ACHBG3RV



Support documents  
CT730-BAU



# CHARIOTS DE DISPENSATION DHIN



Référence  
**HMS-CLS1010KS**  
8 PATIENTS

**SUIVEZ ET GÉREZ  
VOS OUVERTURES  
ET FERMETURES**



Référence  
(Hors accessoires)  
**HMS-MH22002KS**  
16 PATIENTS



Référence  
(Hors accessoires)  
**HMS-MH21003KS**  
24 PATIENTS



Référence  
(Hors accessoires)  
**HMS-MHX2103KS**  
30 PATIENTS



Téléphone portable



NFC



Carte électronique



Clé-plip



Digicode

# CHARIOTS DE DISPENSATION DJIN

## Nouveau !

Optimisez votre parc en adaptant l'ensemble de vos aménagements dans nos structures

Barre de sécurité  
claquable



Référence  
(Hors accessoires)

**HMS-MHXT0300-3P**

27 PATIENTS



10

## Accessoires conseillés



Tablette Rabattable  
CT750L ou R



Côté sale simple tri  
CT726 + CT734.02 + ACHCOR G



Côté sale double tri  
CT726 + CT734.02 + 2 ACHCOR P



Support flaconnage A3/B3  
ACHSUB A3/B3



Support boîte à gants  
CT726 x 3



Tablette de support PC portable  
ACHDAISY.20C

# CHARIOTS DE DISPENSATION DJIN



Référence  
(Hors accessoires)

**HMS-MHT0210-3P**

21 PATIENTS 



Référence  
(Hors accessoires)

**HMS-MHXT1300-2P**

18 PATIENTS 



Référence  
(Hors accessoires)

**HMS-MHXT4300**

40 PATIENTS 

## PROFITEZ DES AMÉNAGEMENTS

Transformez votre tiroir existant en tiroir de dispensation

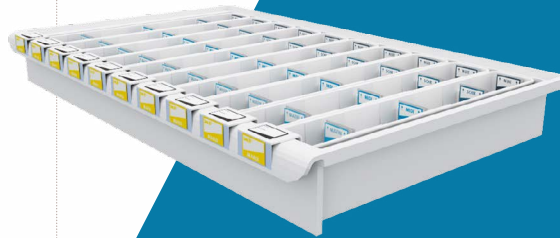

EXEMPLE : TIROIR MARDI

10 PATIENTS 

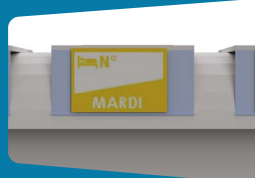

# CHARIOTS DE DIALYSE

Bords arrondis

Garantie 10 ans

Les tiroirs injectés les plus larges du marché



Référence

**HMS-MHX0500**

5 PATIENTS 

## Accessoires conseillés



Porte classeur  
ACHSD1



Subcontainer B3  
ACH238P



Panier  
CT720



Support documents  
CT730-BAU



Tablette Rabattable ou coulissante G/D  
CT750L ou R



Poubelle  
ACHCOR G XL

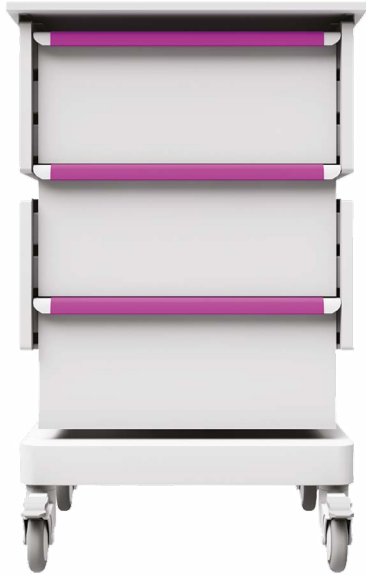

Référence  
**HMS-CLS0030**

3 PATIENTS 

**NOUVEAU**



Référence  
**HMS-MH0600**

6 PATIENTS 



Référence  
**HMS-MHDXST01000**

10 PATIENTS 

Manque d'espace ?  
**Optez pour le stockage vertical !**



Passez de 7 à 10 patients 

**Ou choisissez  
le stockage horizontal !**



8 patients 

10 patients 

# CHARIOTS DE NURSING



Référence

HMS-3NVX-110

## Accessoires conseillés



Poubelle  
ACHCOR G XL



Porte pleine simple  
CT707.142PL



Subcontainer A3/B3  
ACHSUB A3/B3



Panier  
CT720



Porte pleine double  
CT707.242PL



Support boîte à gants  
CT726 x 3

# CHARIOTS DE NURSING

Contrôlez la trajectoire de votre chariot avec la roue directionnelle



AVEC



SANS

Référence

HMS-MBDS1100-1ED



Référence

HMS-3NVX-800



Référence

HMS-3NVX-1300

## RANGÉZ VOTRE MATÉRIEL À L'ABRI DES REGARDS



Référence

HMS-MHDXSS0201

# CHARIOTS D'ANESTHÉSIE

Large plan de préparation

Réglage de la hauteur sans outils



Portique excentré du plan pour une meilleure hygiène

Grande capacité de rangement



Référence  
(Hors accessoires)  
**HMS-MHX2400**



## Accessoires conseillés

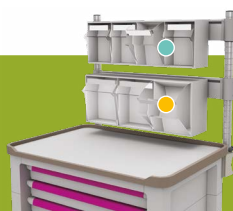

Casiers 3 et 4 bacs basculants  
ACHSTAL3P + ACHSTAL4P



Support boîte à gants  
4ACHBGIPV



Subcontainer B1 + B3  
ACH236PI + ACH238P



Support à aiguilles  
CT734.02 + ACH236PI + ACH238P

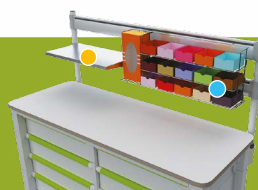

Tablette monitoring et boîte à sutures  
AQU-SUP.BTE.LIG.3 + HMS-TABLETTE-P



Tablette de support PC portable  
ACHDAYSI.20CP + 4ACHBGIPV + ACHSTAL9P



## SÉCURISEZ ET RANGEZ VOS TOXIQUES SANS CLÉ

grâce à notre tiroir serrure double points



Référence  
HMS-MHX4300

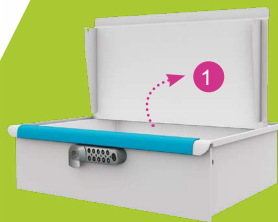

1 Couverture sécurisée sur tiroir



2 Sécurisation par ancrage à l'intérieur du chariot

1 produit, 1 emplacement, 1 étiquette = SÉCURITÉ



32 références



20 références

Sécurisez et rangez vos toxiques

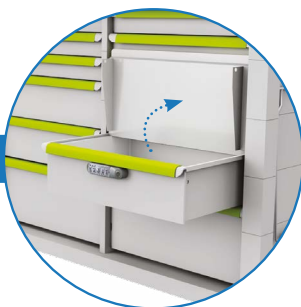

Référence  
(Hors accessoires)  
HMS-MHDST6420

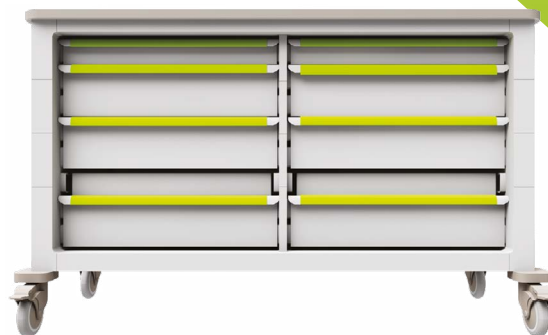

Référence  
HMS-MBDXST2600

# CHARIOTS D'URGENCES

Support perfusion amovible et réglable en hauteur

Support défibrillateur :  
pied pivotant freiné à 270 degrés  
et plateau à 360 degrés

Planche de réanimation au  
dos du chariot, indépendante  
de la structure

De la couleur  
naît la sécurité

Barre pour cadenas à  
usage unique

Référence  
(Hors accessoires)  
**HMS-MBX4200**



## Accessoires conseillés



Support défibrillateur  
CT761



Porte obus et porte sondes  
CT772M + ACH707



Planche réanimation et support perfusion  
CT773 + CT770



Support boîte à aiguilles  
CT734.02



Subcontainer A3/B3  
ACHBUS A3/B3



Support documents  
CT730-BAU

# CHARIOTS D'URGENCES



Référence  
(Hors accessoires)

**HMS-MH3210**



Référence  
(Hors accessoires)

**HMS-MB3110**



Référence  
(Hors accessoires)

**HMS-MHX0500**

## NOUVEAU

Sécurisation par cadenas à usage unique pour un tiroir



Contrôlez immédiatement  
quel tiroir a été utilisé !

# CHARIOTS INFORMATIQUE

Vue de dessus

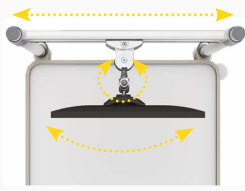

Vue de côté

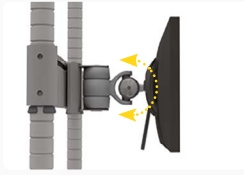

Ecran 24 pouces

Portique ajustable :  
meilleure ergonomie visuelle  
avec un réglage 4D de l'écran

Tablette coulissante  
gauche/droite

Tiroir clavier : extraction totale  
pour une meilleure hygiène



Batterie intégrée :  
Garantie 3 ans

Référence  
(Hors accessoires)

**HMS-MBXT5100-1P**



## BRAS A MONITEUR FLO ET OLLIN



OLN/009/010



DYN/013/007



Mouvement fluide et dynamique - Rotation aisée de l'écran de portrait à paysage

 Tournez et ajustez

 Système de gestion  
des câbles à  
trois points intégrés

 Compatible avec un  
écran tactile

# CHARIOTS INFORMATIQUE



Tiroir clavier avec extraction totale

Batterie intégrée :  
Garantie 3 ans

Référence  
(Hors accessoires)  
**HMS-CLS0110-1P**

Bras à moniteur :  
dirigez votre écran selon votre  
champ de vision



2 écrans  
de 22 pouces

## SUPPORT PC PORTABLE



**ACHDAISY20C (PC non-fourni)**

\*Ecran non-fourni

# FINITION

## COLOR CLIP

Clips de couleurs pour poignée de tiroir



FUSHIA



PRUNE



VIOLET



BLEU



VERT



ORANGE



JAUNE



ROUGE

## Autres coloris de tiroirs



Blanc cassé  
LU



Gris  
HF



Beige  
LT



Gris moyen  
WN



Kaki  
1B



Terre cuite  
ZP



Java  
5B



Génévrier  
2B



Vert d'eau  
3B



Aigue marine  
5E



Bleu foncé  
DA



Bleu nuit  
6F



Prune  
4B



Jaune  
YT



Rouge vif  
VR

## VUE ECLATÉE D'UN CHARIOT



- 1 Dessus chariot  
UIB6KC8
- 2 Vertèbres hautes  
221830
- 3 Vertèbres centrales  
221831
- 4 Vertèbres basses  
Gauche : 221834  
Droite : 221832
- 5 Fond
- 6 Bumpers  
221837
- 7 Roues simples  
SC98117.03HF
- 8 Roues doubles  
TENMIL125
- 9 Tablette coulissante  
UIBCS2C

- 1 Chariot L  
CO212FF
- 2 Jeu de roues double Ø 125  
ACHROULD 125
- 3 Plan simple HPL avec fixation  
CO555T LU
- 4 Plan Prolongé HPL avec fixation  
CO556T LU
- 5 Cadre C  
CO205FF
- 6 Rail support accessoires  
CT782.10
- 7 Pièce de liaison cadre C  
OMEALT
- 8 Tiroir A  
CO207FF
- 9 Tiroir B  
CO208FF
- 10 Tiroir C  
CO209FF
- 11 Support étiquette pour tiroir  
PES480
- 12 Barre de verrouillage digicode L  
CO473EL

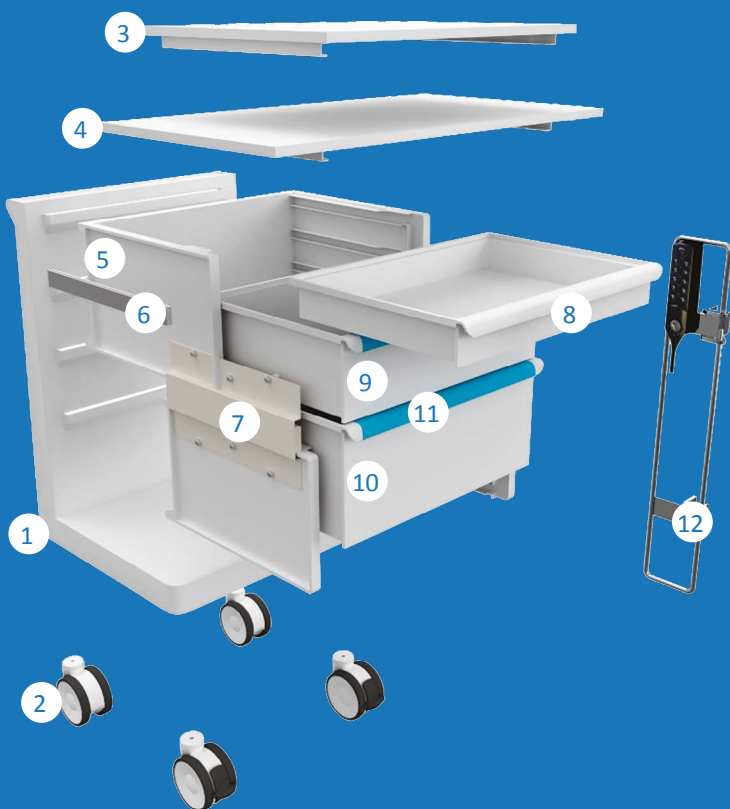



## ECONOMIE CIRCULAIRE

Investissez dans le temps : gardez le même chariot et transformez-le selon vos souhaits grâce aux kits d'extension.



HM-6MHX

HM-7AMX

HM-8AMX

HM-9AMX

TEL : 01 69 02 18 60  
 FAX : 01 69 02 18 69  
 contact@hmsante.com

[www.hmsante.com](http://www.hmsante.com)